



# HBEAM 1.25 BESPOKE

**HB1.25 | SUSPENDED, WALL, SURFACE**

**STANDARD SIZES**

1.25" Aperture  
Configurable in linear shapes and straight run sections  
Continuous linear OR spotlight lamping

**LAMPING**

LED - Direct & Indirect - 80/90 CRI - 3000K/3500K/4000K  
Output Options: MIN/LOW/MED/HI/MAX/RGB  
Dimming down to 0%

**FINISH**

Anodized Aluminum, White, Black, Silver, Brass, RAL Classic Colors

**CONSTRUCTION**

Industrial Strength Extruded 6061 Aluminum

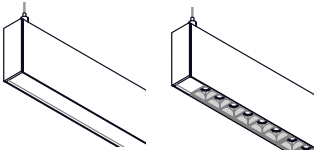



# PRODUCT SUBMITTAL WORKSHEET

## SAMPLE PRODUCT CODE

**HB1.25S – S9 – N – N – N – N – SL/HI/80/3500/25 – SC – 0/10V/S – MED/90/3500 – 0/10V/S – EXT – WH – UNV – EMB/1 – OS/1 – COMBO – SB**

1      2      3      4      5      6      7      8      9      10      11      12      13      14A      14B      14c

### 1. BASE MODEL (CHOOSE ONE)

- HB1.25S** QS 1.25" Suspended
- HB1.25W\*** QS 1.25" Wall-Mount
- HB1.25SMB** QS 1.25" Wall/Surface, Back-Mounted, Front-Facing

\*Not compatible with mitered corner sections.

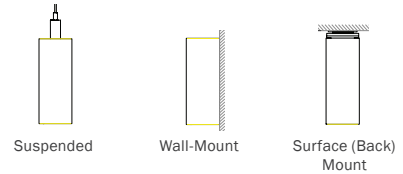

### 2. SHAPE/LENGTH (CHOOSE ONE & ENTER LENGTH GREATER THAN 2 FEET – FOR CUSTOM ANGLES, CONTACT ALW)

- S\_\_** QS Individual/Straight Run Section (enter length, ex. S5)
- SQ\_\_** QS Square Configuration (enter side length A, ex: SQ5)
- R\_\_** QS Rectangular Configuration (enter side lengths A and B, ex. R5-7)
- LL\_\_** QS L-Shaped, Left Configuration (enter side lengths A and B, ex. LL5-7)
- LR\_\_** QS L-Shaped, Right Configuration (enter side lengths A and B, ex. LR5-7)
- U\_\_** QS U-Shaped Configuration (enter side lengths A, B, and C, ex. U5-7-4)

\*Lengths are nominal and may vary based on lamping and other specification selections. Consult ALW when exact lengths are required.

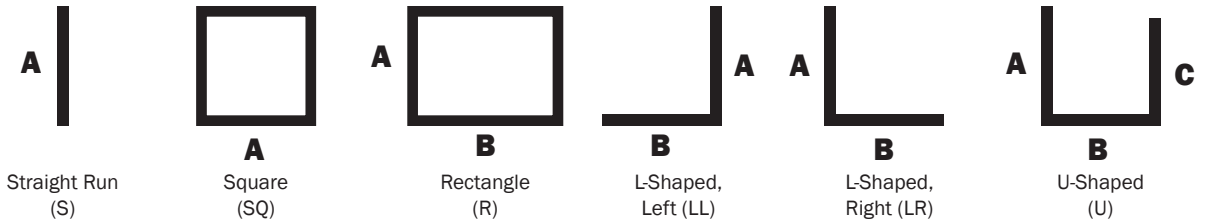

### 3. LED LAMPING – LINEAR/DIRECT (CHOOSE NONE OR ONE UNDER A, B, & C, AS NECESSARY)

- N** QS None. Select when direct lamping is not desired or when specifying continuous spotlights.

#### A. OUTPUT

- QS MIN
- QS LOW
- QS MED
- QS HI
- QS MAX
- RGB

#### B. CRI<sup>1</sup>

- QS 80
- 90

#### C. CCT<sup>1</sup>

- QS 3000K
- QS 3500K
- QS 4000K

DELIVERED LUMENS (LM/FT)	WATTS (W/FT)	EFFICACY (LM/W)
See page 7 for complete details.		Up to 81 lm/W

<sup>1</sup>CRI/CCT not applicable for RGB lamping.

QS = QuickShip-qualifying option. For the entire luminaire configuration to be QuickShip-eligible, ALL options specified in the configuration must be ones notated with "QS". NOTE: Maximum 800 ft. of QuickShip-eligible product per order.

SS120418-A.0



**4. REMOTE DRIVER – LINEAR/DIRECT** (CHOOSE ONE)

- N** QS None. *Select when direct lamping is not desired or when specifying continuous spotlights.*
- 0/10V/S** QS 0-10V dimming down to 5% (Standard Dimming)
- 0/10V/1%** QS 0-10V dimming down to 1%
- 0/10V/0%** 0-10V premium dimming down to 0%
- DALI** DALI flicker-free dimming down to 0%
- DMX** DMX flicker-free dimming down to 0% (Recommended for RGB lamping)
- ECOSYS1** QS Lutron Hi-lume 1% EcoSystem, constant current
- ECOSYS5** Lutron 5-Series 5% EcoSystem, constant current

*\*Driver specifications provided upon request to assist with control system integration.*

**5. LENS – LINEAR/DIRECT** (CHOOSE ONE)

- N** QS None. *Select when specifying continuous spotlights or when direct lamping is not desired. Cover plate provided to match housing finish.*
- EXT** QS Extra diffuse, white frosted

**6. LED SPOTLIGHT – DIRECT** (CHOOSE NONE OR ONE UNDER A, C, & D)

QS – All standard spotlight options below are QuickShip-qualifying.

- N** QS None. *Select when specifying linear lamping or when direct lamping is not desired.*
- SL** QS Continuous (ALL) spotlights. *Must select NONE for Linear/Direct Lamping. Select options (A-D) below.*
- SL3** QS 3 Cluster spotlights - intermittently/evenly spaced ~1ft apart with no linear lamping. *Select options (A-D) below.*
- SL6** QS 6 Cluster spotlights - intermittently/evenly spaced ~1ft apart with no linear lamping. *Select options (A-D) below.*

- |                                     |   |                                       |                                     |
|-------------------------------------|---|---------------------------------------|-------------------------------------|
| <b>A. OUTPUT</b>                    | <b>B. CRI</b>                                 | <b>C. CCT</b>                         | <b>D. BEAM SPREAD</b>               |
| <input type="checkbox"/> <b>MIN</b> | <input checked="" type="checkbox"/> <b>80</b> | <input type="checkbox"/> <b>3000K</b> | <input type="checkbox"/> <b>25°</b> |
| <input type="checkbox"/> <b>LOW</b> |   | <input type="checkbox"/> <b>4000K</b> | <input type="checkbox"/> <b>40°</b> |
| <input type="checkbox"/> <b>MED</b> |   |                                       |                                     |
| <input type="checkbox"/> <b>HI</b>  |   |                                       |                                     |

DELIVERED LUMENS (LM)	WATTS (W)	EFFICACY (LM/W)
See page 7 for complete details.		Up to 89 lm/W

**7. QUANTITY – SPOTLIGHT** (CHOOSE ONE)

- N** QS None. *Select when specifying linear lamping or when direct lamping is not desired.*
- SE** QS Spotlights intermittently spaced. *About 1ft apart with NO linear lamping (cover plate to match finish). Select NONE for Direct Lamping.*
- SC** QS Continuous Row of Spotlights. *Select NONE for Direct Lamping.*

**8. REMOTE DRIVER – SPOTLIGHT** (CHOOSE ONE)

- N** QS None. *Select when specifying linear lamping or when direct lamping is not desired.*
- 0/10V/S** QS 0-10V dimming down to 5%
- 0/10V/1%** QS 0-10V dimming down to 1%
- 0/10V/0%** 0-10V premium dimming down to 0%
- DALI** DALI flicker-free dimming down to 0%
- DMX** DMX flicker-free dimming down to 0%
- ECOSYS1** QS Lutron Hi-lume 1% EcoSystem, constant current
- ECOSYS5** Lutron 5-Series 5% EcoSystem, constant current

*\*Driver specifications provided upon request to assist with control system integration.*

QS = QuickShip-qualifying option. For the entire luminaire configuration to be QuickShip-eligible, ALL options specified in the configuration must be ones notated with "QS". NOTE: Maximum 800 ft. of QuickShip-eligible product per order.

SS120418-A.0



**9. LED LAMPING – INDIRECT** (CHOOSE NONE OR ONE UNDER A, B, & C, AS NECESSARY)

**N** QS None. *Select when specifying SMB base model or when indirect lamping is not desired*

**A. OUTPUT**

- QS MIN**
- QS LOW**
- QS MED**
- QS HI**
- QS MAX**
- RGB**

**B. CRI<sup>2</sup>**

- QS 80**
- 90**

**C. CCT<sup>2</sup>**

- QS 3000K**
- QS 3500K**
- QS 4000K**

DELIVERED LUMENS (LM/FT)	WATTS (W/FT)	EFFICACY (LM/W)
See page 7 for complete details.		Up to 81 lm/W

<sup>2</sup>CRI/CCT not applicable for RGB lamping.

**10. REMOTE DRIVER – INDIRECT** (CHOOSE ONE)

- N** QS None. *Select when specifying SMB base model or when indirect lamping is not desired*
- 0/10V/S** QS 0-10V dimming down to 5% (Standard Dimming)
- 0/10V/1%** QS 0-10V dimming down to 1%
- 0/10V/0%** 0-10V premium dimming down to 0%
- DALI** DALI flicker-free dimming down to 0%
- DMX** DMX flicker-free dimming down to 0% (Recommended for RGB)
- ECOSYS1** QS Lutron Hi-lume 1% EcoSystem, constant current
- ECOSYS5** Lutron 5-Series 5% EcoSystem, constant current

*\*Driver specifications provided upon request to assist with control system integration.*

**11. LENS – INDIRECT** (CHOOSE ONE)

- N** QS None. *Select when specifying SMB base model or when indirect lamping is not desired*
- EXT** QS Extra diffuse, white frosted

**12. FINISH** (CHOOSE ONE)

- AL** QS Natural Anodized Aluminum (Standard Finish)
- BK** QS Black Powder Coat
- BRS** Brass Metallic Powder Coat
- SV** Silver Powder Coat
- WH** QS White Powder Coat
- WH/AM** White Antimicrobial Powder Coat (for healthcare environments)
- RAL\_\_\_\_\_** Specify RAL Classic Color code (ex: RAL3003) [ralcolorchart.com/ral-classic](http://ralcolorchart.com/ral-classic)

**13. VOLTAGE** (CHOOSE ONE)

- UNV** QS Universal Voltage (120VAC-277VAC)
- 347** 347 Volt (*Driver options may be limited*)

QS = QuickShip-qualifying option. For the entire luminaire configuration to be QuickShip-eligible, ALL options specified in the configuration must be ones notated with "QS". NOTE: Maximum 800 ft. of QuickShip-eligible product per order.

SS120418-A.0



## 14. ADDITIONAL OPTIONS (OPTIONAL – CHOOSE ONE UNDER A & B, AND ANY UNDER C, IF DESIRED)

### A. EMERGENCY OPTIONS

- EMB/\_\_\_**<sup>3</sup>      **QS** Emergency Battery (indicate quantity – each battery powers up to a 4ft section)  
 **EMC/\_\_\_**<sup>3</sup>      **QS** Emergency Circuit (indicate quantity of 4ft sections to be illuminated by emergency circuit)

<sup>3</sup>For fixtures under 4ft in length, entire fixture will be illuminated with a proportional lumen output. Consult ALW for available options.

### B. SENSOR OPTIONS (COMPATIBLE ONLY WITH 0-10V DRIVERS – DEFAULT QUANTITY IS 1 SENSOR PER 8FT, INDICATE ALTERNATE QUANTITY IF DESIRED)

- ENLGHT/\_\_\_**<sup>4</sup>      **QS** Enlighted® remote smart sensor (occupancy, daylight, networking, and more)  
 **OS/\_\_\_**              0-10V remote occupancy sensor  
 **PH/\_\_\_**              0-10V remote photocell/daylight sensor

<sup>4</sup>Enlighted® Gateway and Energy Manager (by others) plus programming required. Learn more at [enlightedinc.com](http://enlightedinc.com).

### C. ADDITIONAL OPTIONS (COMPATIBLE ONLY WITH SUSPENDED MODELS)

- COMBO**      **QS** Combination 4.5" canopy at power feed locations to accommodate both power cord & suspension mount hardware.  
 **SB**            **QS** Seismic Bracing

**QS** = QuickShip-qualifying option. For the entire luminaire configuration to be QuickShip-eligible, ALL options specified in the configuration must be ones notated with "QS". NOTE: Maximum 800 ft. of QuickShip-eligible product per order.

SS120418-A.0



## MECHANICAL DIAGRAMS

### SUSPENDED

Suspended mounting can be specified with direct, indirect, or both direct and indirect lamping.

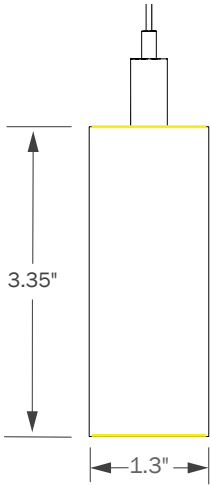

**HB1.25S**  
SUSPENDED MOUNT

### WALL/SURFACE MOUNT

Wall mounting can be specified with direct, indirect, or both direct and indirect lamping. Surface (back) mount can only be specified with direct lamping. There are keyholes on the fixture for wall mounting, as shown.

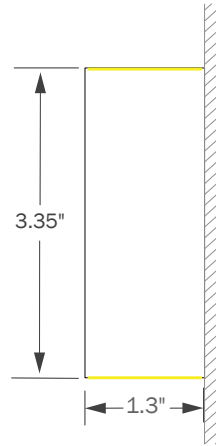

**HB1.25W**  
WALL MOUNT

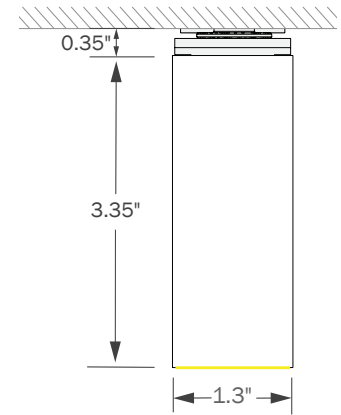

**HB1.25SMB**  
SURFACE (BACK) MOUNT

## SUSPENSION MOUNTING



### CEILING HARDWARE

- (1) 4.5" canopy per power feed location,
- (1) bullet mount,
- (1) 8' aircraft cable
- (1) 2" canopy (for use with T-bar mounting) per suspension point



### COMBO CANOPY

Choose option COMBO to specify 4.5" canopies at feed locations with power feed and aircraft cable suspension mounting. Canopy finish is always white. Contact ALW for alternate colors.

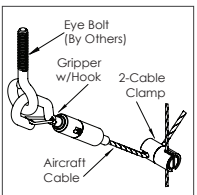

### SEISMIC BRACING

Add-on hardware includes cable gripper with hook, 2-cable clamp and specified length of aircraft cable per suspension point.

## SPOTLIGHT DIMENSIONS

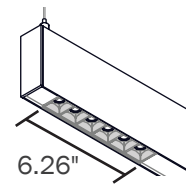
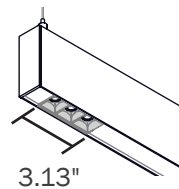

## WALL MOUNTING

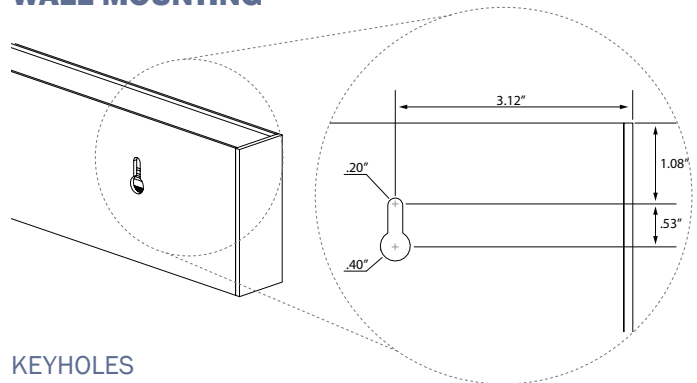

### KEYHOLES

For wall mounting, there will be keyholes on the fixture. The key hole dimensions are shown above, and fit a #8 screw. Keyholes can be specified at different locations along fixture, if necessary.

SS120418-A.0



## PERFORMANCE DETAILS – DIRECT OR INDIRECT LINEAR LAMPING

OUTPUT	DELIVERED LUMENS (LM/FT)	WATTS (W/FT)	EFFICACY (LM/W)	CRI OPTIONS	CCT OPTIONS
MIN <sup>7</sup>	200	2.25	Up to 81 lm/W	80 90	3000K 3500K 4000K
LOW <sup>7</sup>	300	3.375			
MED <sup>7</sup>	400	4.5			
HI <sup>7</sup>	600	6.75			
MAX	800	9.0			
RGB <sup>8</sup>	Color-Changing RGB	5	N/A	N/A	N/A

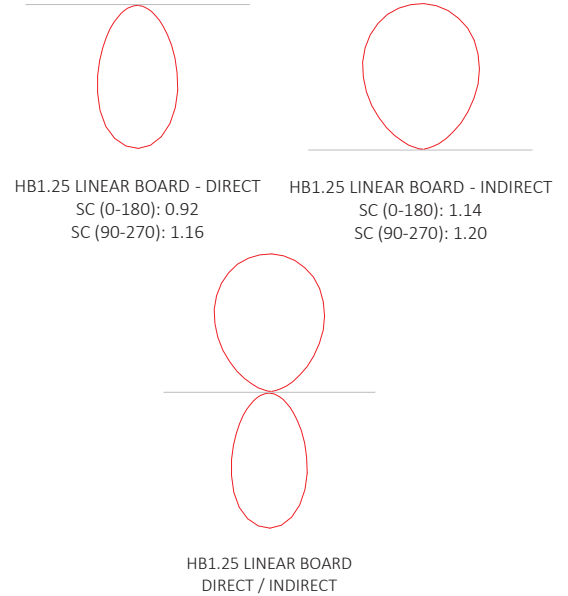

<sup>7</sup>Performance calculations are extrapolated estimates based on actual performance data of MAX output at 80 CRI and 3500K and EXT lens.

<sup>8</sup>DMX driver recommended; controller not included.

## PERFORMANCE DETAILS – SPOTLIGHT LAMPING (PER SL3 CLUSTER – DOUBLE FOR SL6)

OUTPUT	DELIVERED LUMENS (LM)	WATTS (W)	EFFICACY (LM/W)	CRI OPTIONS	CCT OPTIONS
MIN	125	1.4	Up to 89 lm/W	80	3000K 3500K 4000K
LOW	175	2.1			
MED	250	3			
HI	375	4.6			

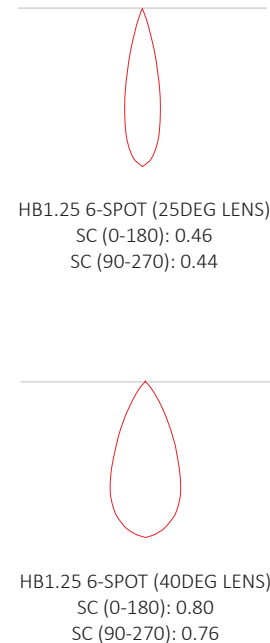

SS120418-A.0



## INTERMITTENTLY SPACED SPOTLIGHT SAMPLE CONFIGURATIONS (NO LINEAR LAMPING)

### 3FT

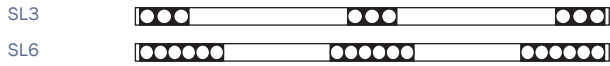

### 4FT



### 5FT

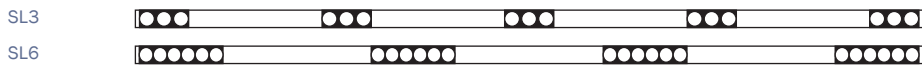

### 6FT

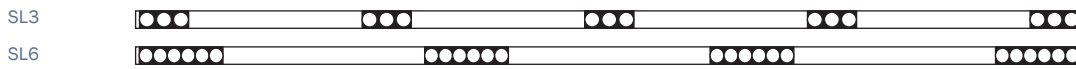

### 7FT

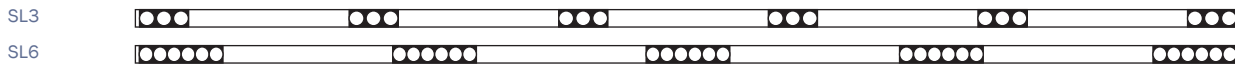

### 8FT



## HB1.25 VOLTAGE DROP CHART FOR REMOTE DRIVERS — WHITE LED (29VDC)

For best performance, ensure proper wire gauge is installed between the remote LED driver and canopy that is dropping power to your fixture. This chart only applies to HB1.25 White LEDs at 24VDC. Do not use this chart to calculate voltage drop for other fixtures.

WIRE GAUGE	20W 0.83A	30W 1.25A	40W 1.67A	50W 2.08A	60W 2.50A	70W 2.92A	80W 3.33A	90W 3.75A	100W 4.17A
18 AWG	90 ft.	58 ft.	41 ft.	31 ft.	25 ft.	20 ft.	16 ft.	14 ft.	11 ft.
16 AWG	150 ft.	97 ft.	70 ft.	55 ft.	44 ft.	37 ft.	31 ft.	27 ft.	23 ft.
14 AWG	242 ft.	158 ft.	117 ft.	92 ft.	75 ft.	63 ft.	54 ft.	48 ft.	42 ft.
12 AWG	390 ft.	257 ft.	190 ft.	151 ft.	124 ft.	105 ft.	91 ft.	80 ft.	71 ft.
10 AWG	623 ft.	413 ft.	307 ft.	245 ft.	202 ft.	172 ft.	150 ft.	132 ft.	118 ft.

## HB1.25 VOLTAGE DROP CHART FOR REMOTE DRIVERS — RGB LED (24VDC)

For best performance, ensure proper wire gauge is installed between the remote LED driver and canopy that is dropping power to your fixture. This chart only applies to HB1.25 RGB LEDs at 24VDC. Do not use this chart to calculate voltage drop for other fixtures.

WIRE GAUGE	20W 0.83A	30W 1.25A	40W 1.67A	50W 2.08A	60W 2.50A	70W 2.92A	80W 3.33A	90W 3.75A	100W 4.17A
18 AWG	59 ft.	37 ft.	26 ft.	19 ft.	14 ft.	11 ft.	8 ft.	7 ft.	5 ft.
16 AWG	99 ft.	63 ft.	46 ft.	35 ft.	28 ft.	22 ft.	18 ft.	15 ft.	13 ft.
14 AWG	163 ft.	106 ft.	77 ft.	60 ft.	49 ft.	40 ft.	34 ft.	30 ft.	26 ft.
12 AWG	264 ft.	173 ft.	128 ft.	100 ft.	82 ft.	69 ft.	60 ft.	52 ft.	46 ft.
10 AWG	424 ft.	280 ft.	208 ft.	165 ft.	136 ft.	115 ft.	100 ft.	88 ft.	78 ft.

SS120418-A.0





## ADDITIONAL OPTIONS & SPECIFICATIONS

### LED PERFORMANCE

For standard lampings:  $L_{70} > 54,000$  hours.  
Luminous flux +/- 5%.

### LENS

Extruded, twin-layered, high-impact acrylic. EXT is white and extra diffuse with minimal-to-no source visibility.

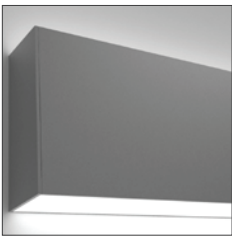

EXT – EXTRA DIFFUSE

### HOUSING

100% recyclable, extruded architectural grade 6061 aluminum with a 0.08" minimum wall thickness.

### SAFETY & REGULATORY

ETL Listed (U.S. & Canada). Suitable for dry or damp locations.  
Conforms to UL std. 2108, Low Voltage Luminaires / Low Voltage Lighting Systems.  
Certified to CSA std. C22.2#9.0:1996 Ed. 1+S1.

### OPERATING TEMPERATURE

Luminaire should be installed and operated ONLY in dry or damp environments where the ambient temperature ranges from -4 °F to 122 °F (-20 °C to 50 °C). Luminaire operation in environments outside the listed temperature range voids the warranty AND may damage the product or adversely impact lamp life, lumen output and color consistency.

### WARRANTY

Limited 5-year warranty. Details: [alwusa.com/warranty](http://alwusa.com/warranty)

### SENSOR OPTIONS

Optional, occupancy detection (OS) and/or daylight harvesting (PS) sensor available. Or upgrade to an optional Enlighted® Smart Sensor (ENLGHT) for additional capabilities. Contact ALW for details.

### FINISH

Standard finish is "Ultimate" aluminum — a smooth, clean, and durable finish achieved from a deep etch and two-step clear anodizing process. Other options are shown below.

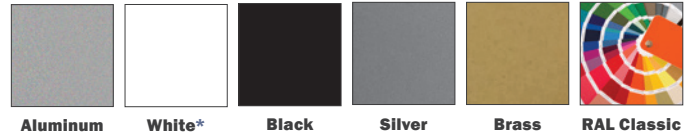

\*For healthcare environments, a white antimicrobial finish (WH/AM) is also available.