



MOONRING MONDO MULTI CIRCLES

RPD06/R1/M | SUSPENDED



DESIGN BY
NEIDHARDT

STANDARD SIZES

Group of three rings sized from 2 to 6 feet

LAMPING

LED - 90+ CRI - 2700K/3000K/3500K/4000K

Output Options: Standard/RGB/RGBW

Dimming down to 0%

FINISH

Brushed Aluminum, White, Black, Silver, Brass, RAL Classic Colors

CONSTRUCTION

Industrial Strength Extruded & Welded Aluminum





PRODUCT SUBMITTAL WORKSHEET

SAMPLE PRODUCT CODE

RPD06-R1/M – 3M/2/3/2 – 3500 – 0/10V/S – LENS – BK – BAL – UNV – EMB

1. BASE MODEL (CHOOSE ONE)

- RPD06-R1/M** Multi-Pendant with (3) R1-style rings (outside tall wall)
- RPD06-R1R/M** Multi-Pendant with (3) R1R-style rings (inside tall wall)
- RPD06-R1E/M** Multi-Pendant with (3) R1E-style rings (both short wall)

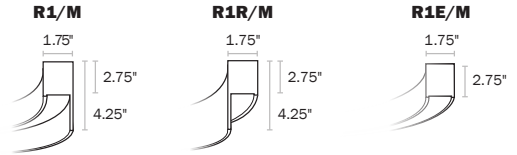

2. NOMINAL SIZE/DIAMETERS (CHOOSE ONE – ALTERNATE SIZE COMBINATIONS MAY BE AVAILABLE, CONTACT ALW)

- 3M/2/3/2** Top Ring: 2ft. Middle Ring: 3ft. Bottom Ring: 2ft.
- 3M/2/4/2** Top Ring: 2ft. Middle Ring: 4ft. Bottom Ring: 2ft.
- 3M/2/5/2** Top Ring: 2ft. Middle Ring: 5ft. Bottom Ring: 2ft.
- 3M/2/6/2** Top Ring: 2ft. Middle Ring: 6ft. Bottom Ring: 2ft.
- 3M/3/4/3** Top Ring: 3ft. Middle Ring: 4ft. Bottom Ring: 3ft.
- 3M/3/5/3** Top Ring: 3ft. Middle Ring: 5ft. Bottom Ring: 3ft.
- 3M/4/3/2** Top Ring: 4ft. Middle Ring: 3ft. Bottom Ring: 2ft.
- 3M/4/5/4** Top Ring: 4ft. Middle Ring: 5ft. Bottom Ring: 4ft.
- 3M/4/6/4** Top Ring: 4ft. Middle Ring: 6ft. Bottom Ring: 4ft.
- 3M/5/3/2** Top Ring: 5ft. Middle Ring: 3ft. Bottom Ring: 2ft.
- 3M/5/4/2** Top Ring: 5ft. Middle Ring: 4ft. Bottom Ring: 2ft.
- 3M/5/4/3** Top Ring: 5ft. Middle Ring: 4ft. Bottom Ring: 3ft.
- 3M/5/6/5** Top Ring: 5ft. Middle Ring: 6ft. Bottom Ring: 5ft.
- 3M/6/3/2** Top Ring: 6ft. Middle Ring: 3ft. Bottom Ring: 2ft.
- 3M/6/4/3** Top Ring: 6ft. Middle Ring: 4ft. Bottom Ring: 3ft.
- 3M/6/4/2** Top Ring: 6ft. Middle Ring: 4ft. Bottom Ring: 2ft.
- 3M/6/5/2** Top Ring: 6ft. Middle Ring: 5ft. Bottom Ring: 2ft.
- 3M/6/5/3** Top Ring: 6ft. Middle Ring: 5ft. Bottom Ring: 3ft.

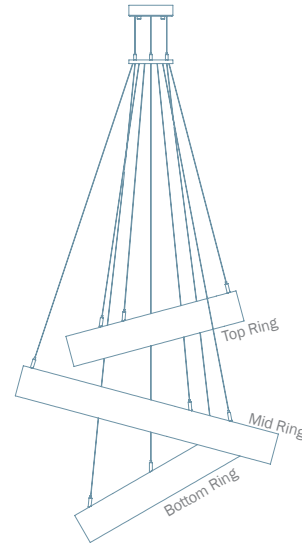

3. LED LAMPING (CHOOSE ONE)

- 2700** 2700K (very warm)
- 3000** 3000K (warm)
- 3500** 3500K (slightly warm)
- 4000** 4000K (neutral)
- RGB** Red, Green, and Blue LED
- RGBW** Red, Green, Blue, and White (4000K) LED

DELIVERED LUMENS (LM)	WATTS (W)	EFFICACY (LM/W)
See page 4 for complete details.		~41

4. REMOTE DRIVER (CHOOSE ONE)

- 0/10V/S** 0-10V dimming down to 10% (Standard Dimming)
- 0/10V/1%** 0-10V dimming down to 1%
- 0/10V/0%** 0-10V premium dimming down to 0%
- DMX** DMX flicker-free dimming down to 0% (Recommended for RGB or RGBW lamping)
- ECOSYS1** Lutron Hi-lume 1% EcoSystem, constant current or constant voltage
- LTEA** Lutron Hi-lume 1% 2-wire TRIAC dimming (120V forward-phase only), constant current or constant voltage

5. LENS – PRIMARY/DIRECT

- LENS** Extra diffuse lens

SS110618-A.0



RPD06-E1 & E1R

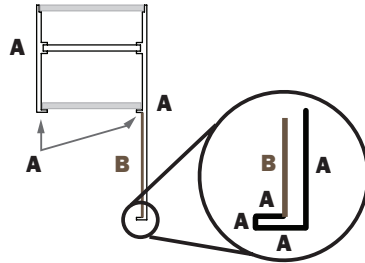

RPD06-E1E

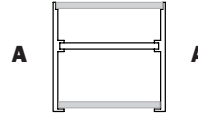

6. FINISH – SURFACE (A) (CHOOSE ONE)

- BAL** Brushed Aluminum
- BK** Black Powder Coat
- BRS** Brass Metallic Powder Coat
- SV** Silver Powder Coat
- WH** White Powder Coat
- WH/AM**  White Antimicrobial Powder Coat (for healthcare environments)
- RAL_____** Specify RAL Classic Color code (ex: *RAL3003*) ralcolorchart.com/ral-classic

7. FINISH – SURFACE (B) (CHOOSE ONE - NOT APPLICABLE FOR RPD06/R1E BASE MODEL)

- BAL** Brushed Aluminum
- BK** Black Powder Coat
- BRS** Brass Metallic Powder Coat
- SV** Silver Powder Coat
- WH** White Powder Coat
- WH/AM**  White Antimicrobial Powder Coat (for healthcare environments)
- RAL_____** Specify RAL Classic Color code (ex: *RAL3003*) ralcolorchart.com/ral-classic

8. VOLTAGE

- UNV** Universal Voltage (120VAC-277VAC)

9. EMERGENCY OPTIONS (OPTIONAL)

- EMB** Emergency Battery Pack



MECHANICAL DIAGRAMS – INDIVIDUAL RINGS

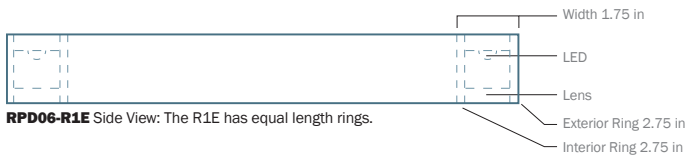
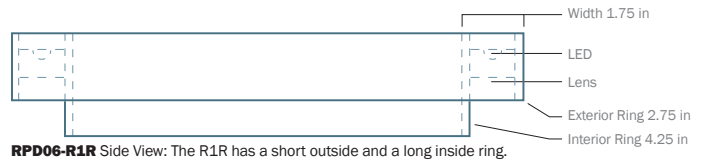

MOUNTING DIAGRAM

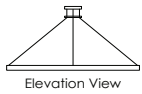
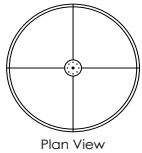

Central Collared Suspension (CCS)

- (1) 5" white central axis canopy and
- (1) 5" collared ring (color matches specified body finish) that all aircraft cables and power feeds route through.

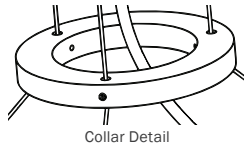

PERFORMANCE & MOUNTING DETAILS

RING DIAMETER	LUMENS (LM) at 3000K ³	WATTS (W)	POWER DROPS ¹ (0/10V/S Driver) ³	REMOTE DRIVER BOXES ² (0/10V/S Driver) ³	SUSPENSION POINTS	FIXTURE SECTIONS	APPROX. WEIGHT (LBS)	CENTRAL AXIS, OR COLLARED
D2	1473	36	1	1	3	1x Ring	TBD	YES
D3	2281	56	1	1	3	1x Ring	TBD	YES
D4	2968	72	1	1	3	1x Ring	TBD	YES
D5	3854	99	1	2	3	1x Ring	TBD	YES
D6	4637	116	1	2	3	1x Ring	TBD	YES

¹Power Drop refers to the total quantity of canopies dropping low voltage power to the fixture. Each canopy may have multiple wire feeds supplying power to the fixture.

²One or more drivers may be enclosed in each Remote Driver Box. See your final drawing/submittal for details.

³Applies to 0/10V/S drivers. For additional info on other driver models see your final drawing/submittal.



HOW TO CALCULATE VOLTAGE DROP?

Your MoonRing may be powered with more than 1x Class 2 LED driver. Let's use the 24VDC chart below as an example.

1. Determine Load Size of Each Circuit

- a. Open the driver enclosure and you'll see a silver sticker that indicates the Power (Wattage).
- b. Let's say the load is 45W. Round up to the nearest load, which is 50W.

2. Determine Distance from Driver to Load

Let's assume the distance is 60 ft.

3. Determine Wire Gauge

In this example, ALW recommends to install 12 AWG wire between the Driver and Canopy (where power drops to the ring).

MOONRING MONDO MULTI CIRCLES VOLTAGE DROP CHART FOR REMOTE DRIVERS – WHITE LED, 24VDC

For best performance, ensure proper wire gauge is installed between the remote LED driver and canopy that is dropping power to your fixture. This chart only applies to RPD06/R1/M at 24VDC. Do not use this chart to calculate voltage drop for other fixtures.

WIRE GAUGE	D2 36W	D3 56W	D4 72W	D5 99W	D6 58W (x2)
18 AWG	29 ft.	16 ft.	10 ft.	5 ft.	15 ft.
16 AWG	51 ft.	30 ft.	21 ft.	13 ft.	29 ft.
14 AWG	87 ft.	53 ft.	39 ft.	26 ft.	50 ft.
12 AWG	143 ft.	89 ft.	67 ft.	46 ft.	85 ft.
10 AWG	232 ft.	146 ft.	112 ft.	79 ft.	141 ft.

MOONRING MONDO MULTI CIRCLES VOLTAGE DROP CHART FOR DMX REMOTE DRIVERS – RGB/W LED, 24VDC

WIRE GAUGE	D2 29W	D3 45W	D4 58W	D5 79W	D6 46W (x2)
18 AWG	38 ft.	22 ft.	15 ft.	9 ft.	21 ft.
16 AWG	66 ft.	39 ft.	29 ft.	19 ft.	38 ft.
14 AWG	109 ft.	68 ft.	50 ft.	35 ft.	66 ft.
12 AWG	179 ft.	112 ft.	85 ft.	60 ft.	110 ft.
10 AWG	290 ft.	184 ft.	141 ft.	101 ft.	180 ft.



ADDITIONAL OPTIONS & SPECIFICATIONS

LENS

Extra diffused opal acrylic lens (LENS).

HOUSING

100% recyclable, extruded architectural grade aluminum

SAFETY & REGULATORY

ETL Listed (U.S. & Canada). Suitable for dry or damp locations.
Conforms to UL std. 2108, Low Voltage Luminaires / Low Voltage Lighting Systems.
Certified to CSA std. C22.2#250.0:2008 Ed. 3+G1;G2.

OPERATING TEMPERATURE

Luminaire should be installed and operated ONLY in dry or damp environments where the ambient temperature ranges from -4 °F to 122 °F (-20 °C to 50 °C). Luminaire operation in environments outside the listed temperature range voids the warranty AND may damage the product or adversely impact lamp life, lumen output and color consistency.

FINISH



**Brushed
Aluminum**

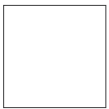

White*



Black



Silver



Brass



RAL Classic

**For healthcare environments, a white antimicrobial finish (WH/AM) is also available.*