



GLASS ACT — SINGLE

RPD14 | SUSPENDED, WALL, SURFACE

DESIGN BY
NEIDHARDT

STANDARD SIZES
Ceiling, Suspended Pendant, or Single/Double-Sided Wall Mount Luminaire

LAMPING
LED - 90+ CRI - 2700K/3000K/3500K/4000K
Output: 500lm (at 83 lm/W) per luminaire
Dimming down to 0%

FINISH
Brushed Aluminum, White, Black, Silver, Brass, RAL Classic Colors

CONSTRUCTION
Industrial Strength Extruded Aluminum

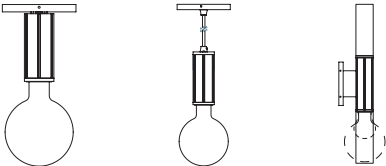



PRODUCT SUBMITTAL WORKSHEET

SAMPLE PRODUCT CODE

RPD14P – 3500 – 0/10V/0% – G40 – FGT – BAL – ZIGZAG – UNV – EMB/1 – 12ft

1. BASE MODEL (CHOOSE ONE)

- RPD14C** Ceiling or Wall Mount
- RPD14P** Suspended Pendant
- RPD14S** Single-Sided Wall Sconce
- RPD14DS** Double-Sided Wall Sconce

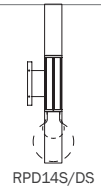

2. LED LAMPING (CHOOSE ONE – 500 LM AND 6 W PER LAMP)

- 2700** 2700K (very warm)
- 3000** 3000K (warm)
- 3500** 3500K (slightly warm)
- 4000** 4000K (neutral)

3. REMOTE DRIVER (CHOOSE ONE)

- 0/10V/S** 0-10V dimming down to 10% (Standard Dimming)
- 0/10V/1%** 0-10V dimming down to 1%
- 0/10V/0%** 0-10V premium dimming down to 0%
- DMX** DMX flicker-free dimming down to 0%
- ECOSYS1** Lutron Hi-lume 1% EcoSystem, constant current or constant voltage
- ECOSYS5** Lutron Hi-lume 5% EcoSystem, constant current

4. SHADE STYLE (CHOOSE ONE)

- G40** G40 style bulb
- A19** A19 style bulb
- T10** T10 style bulb
- AL** Acrylic lens

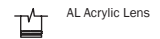
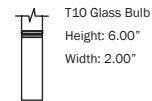
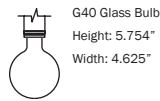

5. SHADE FINISH (CHOOSE ONE)

- CG** Clear (no frosting / 100% clear)
- FG** Fully frosted (100% frosted)
- FGT** Frosted furthest from the shade holder
- FGB** Frosted nearest to the shade holder

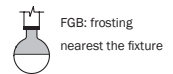



6. BODY FINISH (CHOOSE ONE)

- BAL** Brushed Aluminum
- BK** Black Powder Coat
- BRS** Brass Metallic Powder Coat
- SV** Silver Powder Coat
- WH** White Powder Coat
- WH/AM**  White Antimicrobial Powder Coat (for healthcare environments)
- RAL_____** Specify RAL Classic Color code (ex: *RAL3003*) ralcolorchart.com/ral-classic

7. CORD COLOR (FOR SUSPENDED PENDANT ONLY – CHOOSE ONE)

- BK** Black
- ZIGZAG** Black & White Zig-Zag
- WH** White
- CCC:_____** Custom Color Cord Code (Select from Solid, Patterned, Neon or Shine options only and indicate code, ex: *CCC:W3-620*) colorcord.com

8. VOLTAGE

- UNV** Universal Voltage (120VAC-277VAC)

9. EMERGENCY OPTIONS (OPTIONAL)

- EMB** Emergency Battery Pack

10. ADDITIONAL OPTIONS (OPTIONAL)

- ___ft** Indicate here if a cord length longer than 8ft is required (ex: *12ft*)



MECHANICAL DIAGRAMS – CEILING/WALL MOUNT (C)

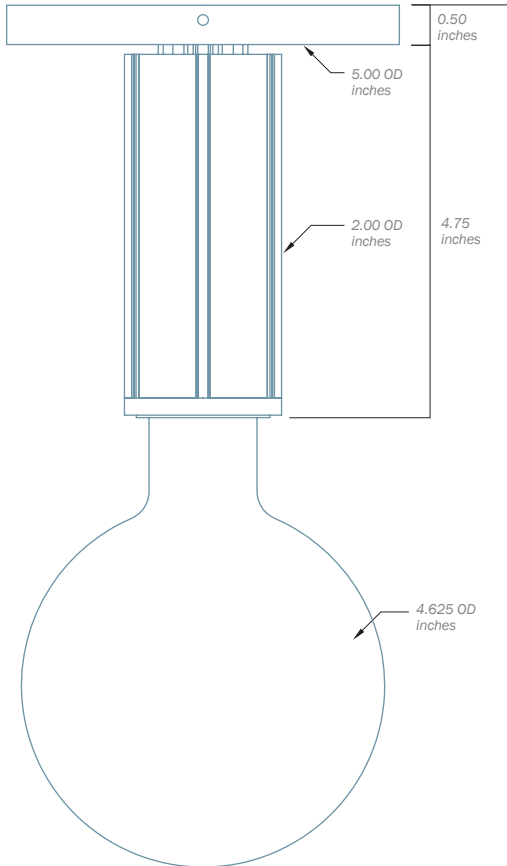

RPD14C: Side view - seen here with a G40 bulb

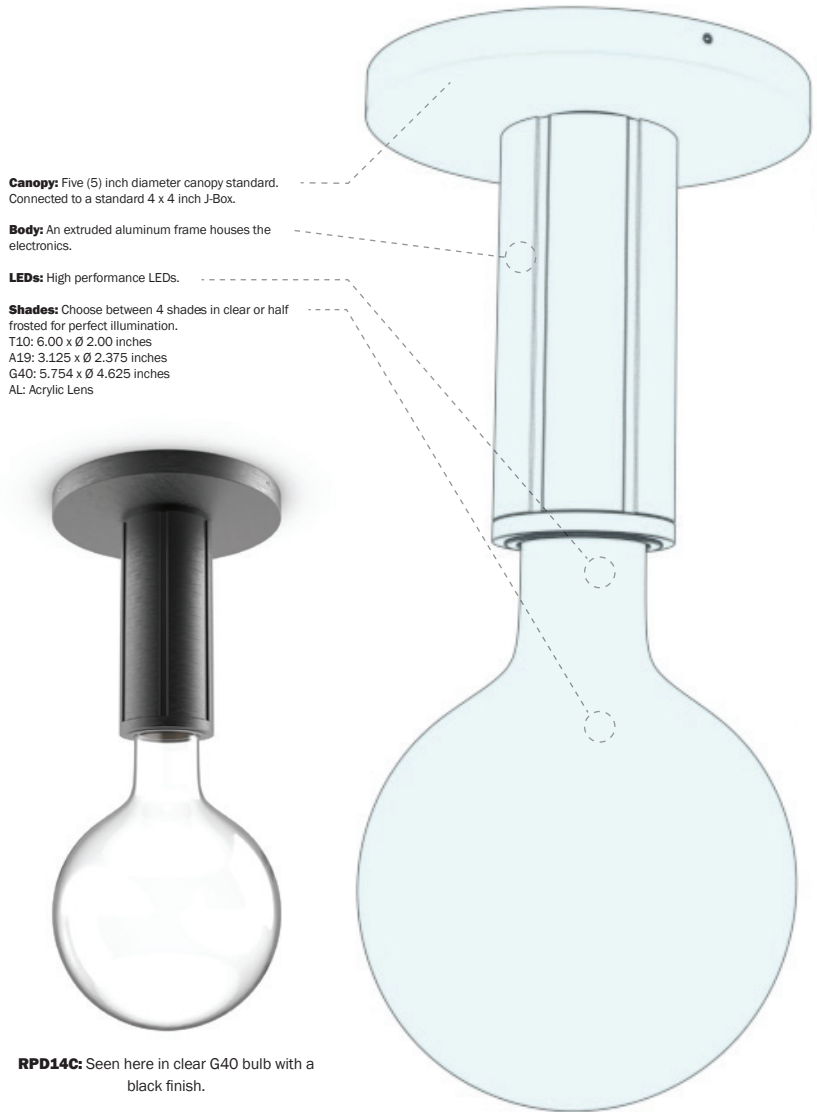

RPD14C: Seen here in clear G40 bulb with a black finish.



MECHANICAL DIAGRAMS – SUSPENDED PENDANT (P)

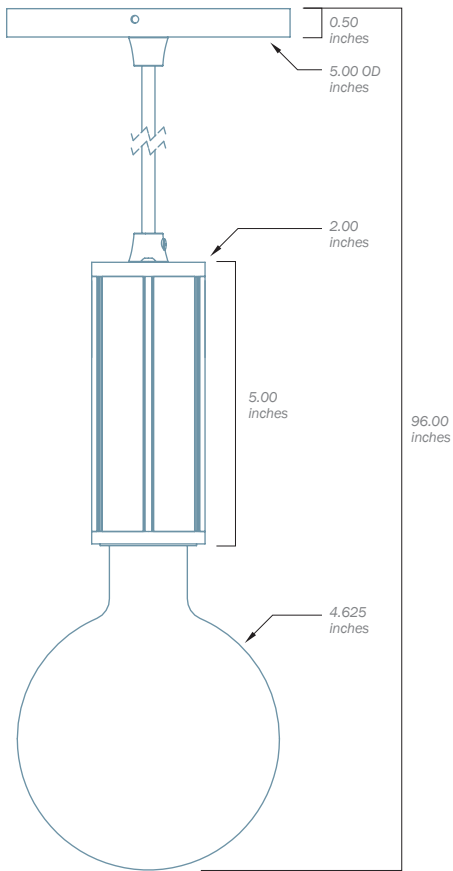

RPD14P: Side view - seen here with a G40 bulb



RPD14P: Seen here with a clear glass G40 lamp with a black finish and a black cord.

Canopy: Five (5) inch diameter canopy standard. Connected to a standard 4 x 4 inch J-Box.

Cord Suspension: Each cloth cord connects to the canopy.

Body: An extruded aluminum frame houses the electronics.

LEDs: High performance LEDs.

Shades: Choose between 4 shade types in clear or half frosted shade finishes.

T10: 6.00 x Ø 2.00 inches

A19: 3.125 x Ø 2.375 inches

G40: 5.754 x Ø 4.625 inches

AL: Acrylic Lens

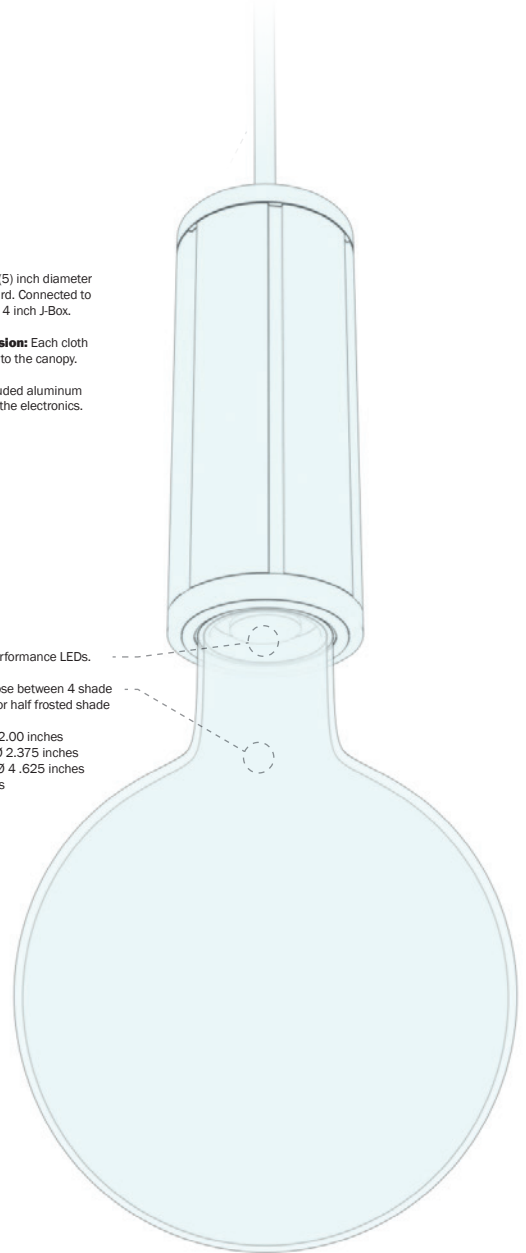

MECHANICAL DIAGRAMS – SINGLE/DOUBLE-SIDED WALL SCONCE (S/DS)

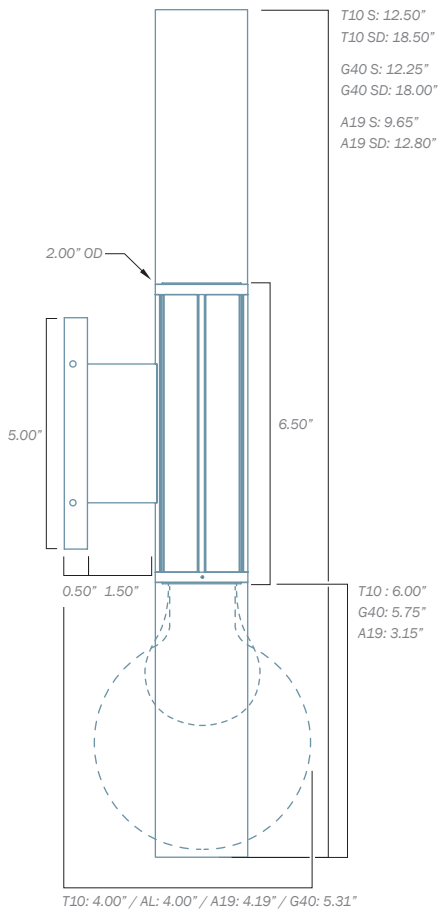

RPD14DS: Side view - seen here with two T10 bulbs (A19 and G40 in dashed lines).



RPD14DS: Seen here with two clear T10 bulbs with a black finish.

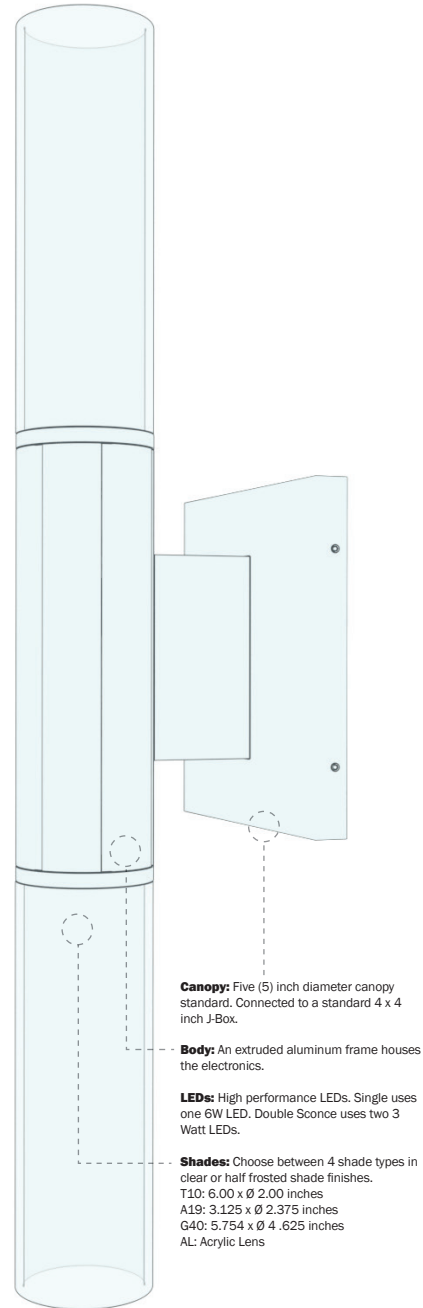



ADDITIONAL OPTIONS & SPECIFICATIONS

HOUSING

100% recyclable, extruded architectural grade aluminum frame

SAFETY & REGULATORY

ETL Listed (U.S. & Canada). Suitable for dry locations only.
Conforms to UL std. 2108, Low Voltage Luminaires / Low Voltage Lighting Systems.
Certified to CSA std. C22.2#250.0:2008 Ed. 3+G1;G2.

OPERATING TEMPERATURE

Luminaire should be installed and operated ONLY in environments where the ambient temperature ranges from -4 °F to 122 °F (-20 °C to 50 °C). Luminaire operation in environments outside the listed temperature range voids the warranty AND may damage the product or adversely impact lamp life, lumen output and color consistency.

WARRANTY

Limited 5-year warranty. Details: alwusa.com/warranty

MAXIMUM WIRE LENGTH (VOLTAGE DROP) – 34VDC

Use this chart to calculate maximum wire length between the canopy J-Box and remote driver. For best performance, ensure proper wire gauge is installed between the remote LED driver and canopy that is dropping power to your fixture.

WIRE GAUGE	6W 0.18A
18 AWG	444 ft.
16 AWG	711 ft.
14 AWG	1136 ft.
12 AWG	1811 ft.
10 AWG	2885 ft.

This chart only applies to RPD14 (single) at 34VDC. Please see alwusa.com/voltage-drop-calculator/ to calculate voltage drop for other fixtures.

FINISH

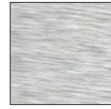

Brushed
Aluminum

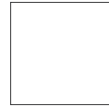

White*



Black



Silver



Brass



RAL Classic

**For healthcare environments, a white antimicrobial finish (WH/AM) is also available.*